



ACO BoxDrain

Hygienic Stainless Steel Drainage
for Food & Beverage Applications

BoxDrain Bodies

BoxDrain Grates

Outlet Connections



BoxDrain Hygienic Features & Benefits

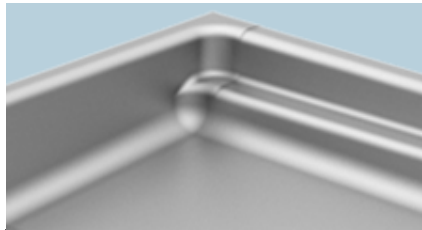

Internal Radii

All internal radii equal or larger than 1/8" (3 mm) which greatly increases cleaning effectiveness.

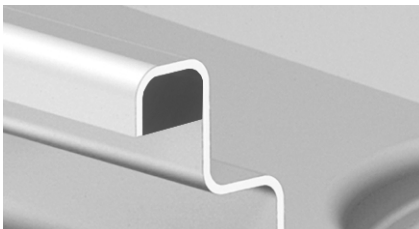

Edge In-fill

Ensures stable and durable connection between the floor drain and surrounding floor and helps to minimize risk of floor cracks which could harbor microorganisms.

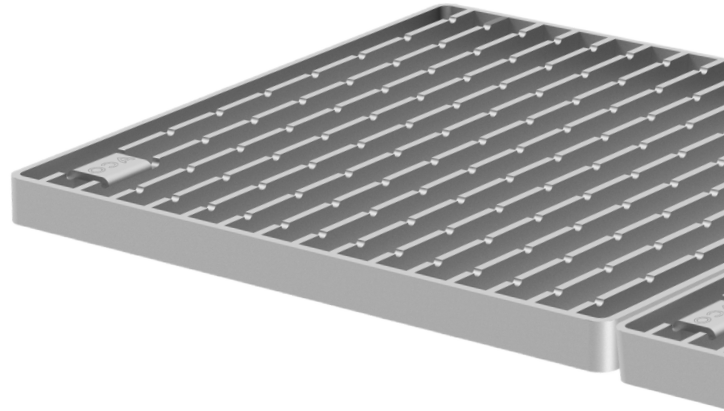

Full Drainability

Dry sump design, completely drainable - eliminating standing water, smells, microbial growth and potential chemical hazards.

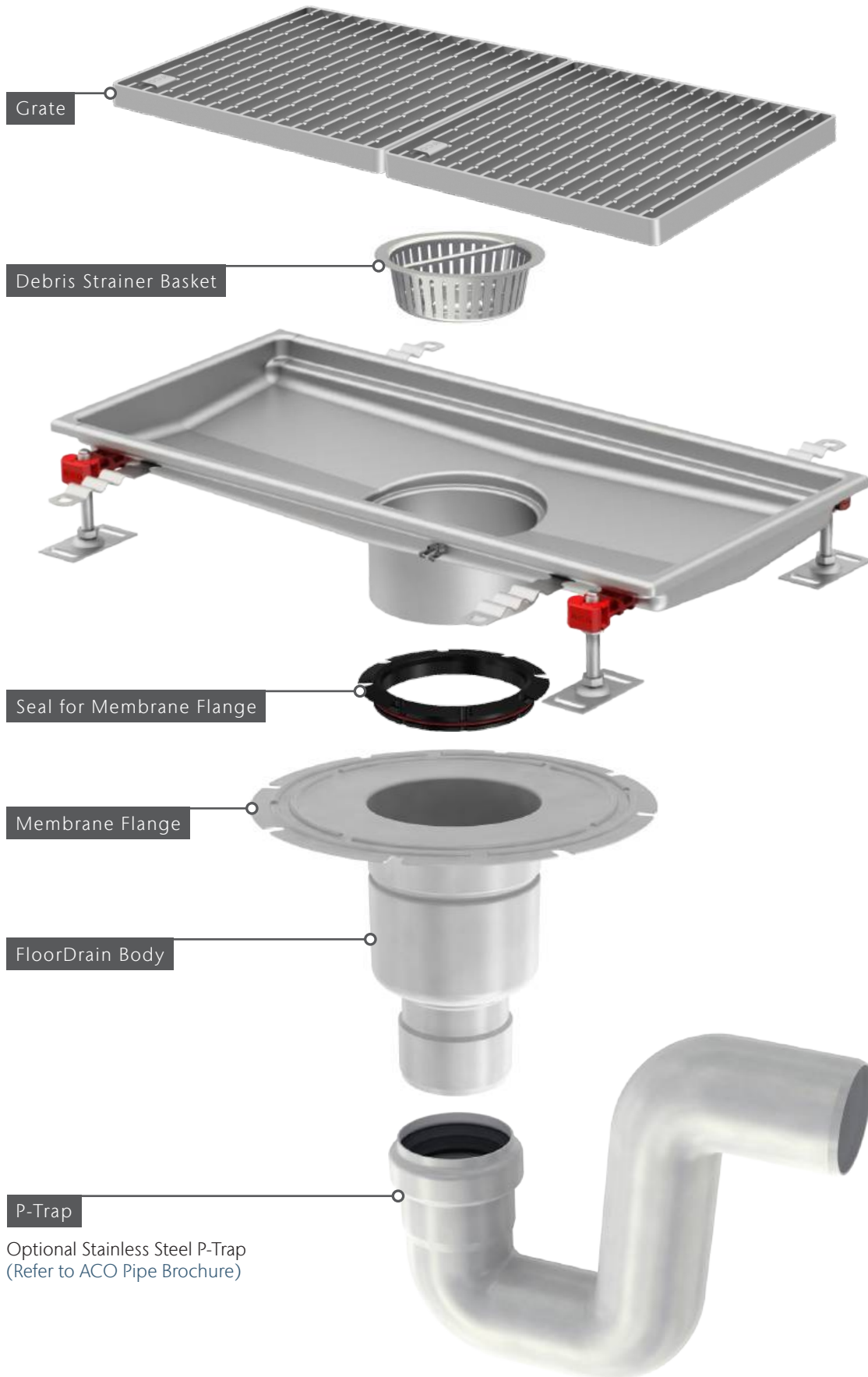

Note:
BoxDrain can be connected to pipework if no membrane present.

BoxDrain Bodies

8" BoxDrain200

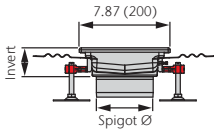

Part No. AISI 316L	Part No. AISI 304	Overall Width in (mm)	Overall Length in (mm)	Invert Depth in (mm)	Overall Depth in (mm)	Spigot Ø in (mm)	Outlet Options
416608	416590	7.87 (200)	20.87 (530)	2.36 (60)	4.80 (122)	5.59 (142) ²	10" FloorDrain Body with 4" Outlet See page 17
416609	416591		32.68 (830)				
416610	416592		40.55 (1030)				
416611	416593		48.43 (1230)				
416612	416594		60.24 (1530)				
416613	416595		79.92 (2030)				

12" BoxDrain300

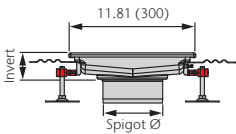

Part No. AISI 316L	Part No. AISI 304	Overall Width in (mm)	Overall Length in (mm)	Invert Depth in (mm)	Overall Depth in (mm)	Spigot Ø in (mm)	Outlet Options
416635	416621	11.81 (300)	12.99 (330)	2.36 (60)	4.72 (120)	7.87 (200) ³	200 mm Pipe ACO Pipe Catalog or ACO P-Trap ACO Pipe Catalog or 12" FloorDrain Body with 4"/6" Outlet See page 17
416636	416622		24.80 (630)				
416637	416623		40.55 (1030)				
416638	416624		60.24 (1530)				
416639	416625		79.92 (2030)				
416640	416626		119.29 (3030)				

16" BoxDrain400

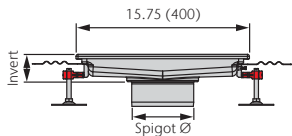

Part No. AISI 316L	Part No. AISI 304	Overall Width in (mm)	Overall Length in (mm)	Invert Depth in (mm)	Overall Depth in (mm)	Spigot Ø in (mm)	Outlet Options
416651	416645	15.75 (400)	16.93 (430)	2.36 (60)	4.72 (120)	7.87 (200) ³	200 mm Pipe ACO Pipe Catalog or ACO P-Trap ACO Pipe Catalog or 12" FloorDrain Body with 4"/6" Outlet See page 17
416652	416646		24.80 (630)				
416653	416647		32.68 (830)				

20" BoxDrain500

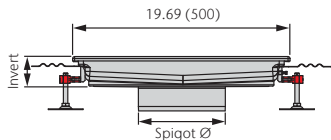

Part No. AISI 316L	Part No. AISI 304	Overall Width in (mm)	Overall Length in (mm)	Invert Depth in (mm)	Overall Depth in (mm)	Spigot Ø in (mm)	Outlet Options
416663	416657	19.69 (500)	20.87 (530)	2.56 (65)	4.88 (124)	7.87 (200) ³	200 mm Pipe ACO Pipe Catalog or ACO P-Trap ACO Pipe Catalog or 12" FloorDrain Body with 4"/6" Outlet See page 17
416664	416658		32.68 (830)				
416665	416659		40.55 (1030)				

Note:
Refer to page 17 for FloorDrain bodies.

1. Use 414339/414340 or 445232/445233 debris strainer basket - See page 10
2. Use 408202/408212 or 445234/445235 debris strainer basket - See page 10
3. Use 408222/408232 or 445236/445237 debris strainer basket - See page 10

BoxDrain Bodies & Accessories

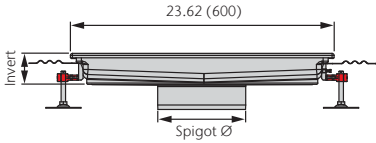
	Part No. AISI 316L	Part No. AISI 304	Overall Width in (mm)	Overall Length in (mm)	Invert Depth in (mm)	Overall Depth in (mm)	Spigot Ø in (mm)	Outlet Options
24" BoxDrain600 	416669	416666		24.80 (630)		5.11 (130)	7.87 (200) ³	200 mm Pipe <i>ACO Pipe Catalog</i>
	416670	416667	23.62 (600)	36.61 (930)	2.76 (70)	4.88 (124)		ACO P-Trap <i>ACO Pipe Catalog</i>
	416671	416668		48.43 (1230)		4.92 (125)		12" FloorDrain Body with 4"/6" Outlet <i>See page 17</i>

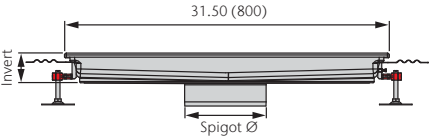
	Part No. AISI 316L	Part No. AISI 304	Overall Width in (mm)	Overall Length in (mm)	Invert Depth in (mm)	Overall Depth in (mm)	Spigot Ø in (mm)	Outlet Options
32" BoxDrain800 	416673	416672	31.50 (800)	32.68 (830)	3.15 (80)	5.23 (133)	7.87 (200) ³	200 mm Pipe <i>ACO Pipe Catalog</i>
								ACO P-Trap <i>ACO Pipe Catalog</i>
								12" FloorDrain Body with 4"/6" Outlet <i>See page 17</i>

	Part No. AISI 316L	Part No. AISI 304	Depth in (mm)	For Spigot Ø in (mm)
Debris Strainer Baskets 	408212	408202	2.0 (50)	5.59 (142)
	445235	445234	3.9 (100)	
	408232	408222	2.0 (50)	7.87 (200)
	445237	445236	5.3 (135)	

	Part No. AISI 316L	Part No. AISI 304	Depth in (mm)	For Spigot Ø in (mm)
Portable Funnel	N/A	415821	9.84 (250)	9.84 (250)



Note:
Refer to page 17 for FloorDrain bodies.

1. Use 414339/414340 or 445232/445233 debris strainer basket
2. Use 408202/408212 or 445234/445235 debris strainer basket
3. Use 408222/408232 or 445236/445237 debris strainer basket

BoxDrain Grate Selection (Cont.)

SLIP RESISTANCE

Slip resistance is critical for user safety in pure water environments or wet floor areas.

ACO recommends alignment between the slip resistance of the floor and of the grate to provide a smooth transition and not create a trip hazard.

A number of test options are available;

■ **Pendulum Test** - Most accepted pedestrian slip resistance test method in the world. A pendulum is swung over a wet surface and friction properties are measured. Results are assigned a BPN value - values in excess of 36 would be used.

■ **Variable Angle Ramp Test** - Grates are installed on a mechanical ramp that inclines while a user walks up and down until it becomes unstable. This test is repeated 3 times to create an average "R" value. The higher the "R value" the higher the slip resistance.

Slope, presence of surface contaminants (grease/oil), etc. can also negatively affect slip and skid resistance and may require a higher slip resistance grate.

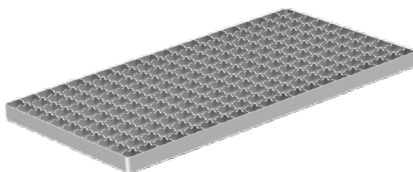
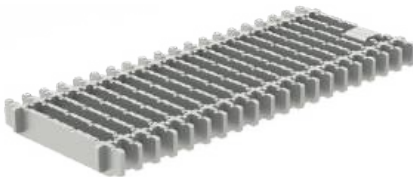
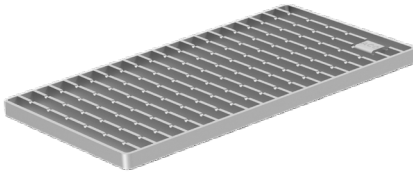

Grate Style	Slip Resistance	Pendulum Test Data BPN Value	Wet Ramp Test Data R-Value
Ladder	✓	45	R11
Frameless Ladder	✓	51	R12
Mesh	✓	62	R11
Slot	✓	-	R11

BPN Value	Likelihood of a Slip*	BPN Value	R-Value
36	1 in a Million	11-18	R9
34	1 in 100,000	18-34	R10
29	1 in 10,000	34-51	R11
27	1 in 200	51-70	R12
24	1 in 20	70+	R13

* Construction Industry Research and Information Association (UK CIRIA) Safer Surfaces to walk on 2006.

Slopes - ramps, etc. create an increased risk of slips, even a 5 degree slope requires a higher slip resistance value to be used - minimum Pendulum Test Value (BPN) of 45, or minimum of R12, ideally R13 rating for any slopes.

Flooring contaminants - water, grease, oils, etc. will affect slip resistance and higher slip resistance values should be considered. Application specific test can be carried out as necessary.

To minimize the slip/trip hazard impact of a drainage grate, where possible, design the drainage system to be located out of the main area of traffic - close to equipment, walls etc. This may also allow a lower load rating to be used.

BoxDrain Grates

Ladder Grate

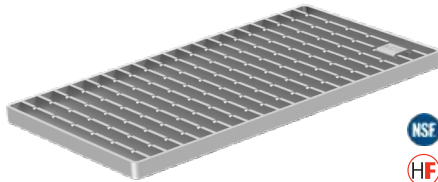

Part No. AISI 316L	Part No. AISI 304	Load Class		EN 1433	ASME	EN 1253	Slip Resistance	Open Area sq in
		To suit Box Drain Width in (mm)	Grate Length in (mm)					
416809	416808	7.87 (200)	15.75 (400)	A15	LD	R50		80.2
416803	416802		19.69 (500)					101.0
416811	416810		15.75 (400)	B125	MD	M125		76.7
416805	416804		19.69 (500)					96.5
416847	416846		15.75 (400)	C250	HD	N250		87.9
416845	416844		19.69 (500)					92.3
416813	416812	11.81 (300)	11.81 (300)	A15	LD	R50		98.0
416815	416814		19.69 (500)					164.8
416817	416816		11.81 (300)	B125	MD	M125		92.1
416819	416818		19.69 (500)					156.7
416851	416850		11.81 (300)	C250	HD	N250		87.7
416849	416848		19.69 (500)					161.1
416821	416820	15.75 (400)	15.75 (400)	A15	LD	R50		180.9
416823	416822		23.62 (600)					274.6
416825	416824		15.75 (400)	B125	MD	M125		172.6
416827	416826		23.62 (600)					261.4
416831	416830	19.69 (500)	15.75 (400)	A15	LD	R50		221.1
416829	416828		19.69 (500)					279.0
416835	416834		15.75 (400)	B125	MD	M125		214.6
416833	416832		19.69 (500)					269.8
416839	416838	23.62 (600)	11.81 (300)	A15	LD	R50	✓	191.4
416843	416842	31.50 (800)	15.75 (400)	A15	LD	R50	✓	356.1

Frameless Ladder Grate

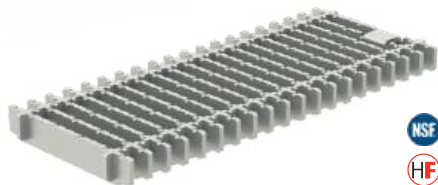

Part No. AISI 316L	Part No. AISI 304	Load Class		EN 1433	ASME	EN 1253	Slip Resistance	Open Area sq in
		To suit Box Drain Width in (mm)	Grate Length in (mm)					
446251	446250	7.87 (200)	15.75 (400)	A15	LD	R50		76.2
446247	446246		19.69 (500)					95.5
446253	446252		15.75 (400)	B125	MD	M125		72.6
446249	446248		19.69 (500)					90.7
446259	446258	11.81 (300)	11.81 (300)	A15	LD	R50		94.7
446255	446254		19.69 (500)					158.7
446261	446260		11.81 (300)	B125	MD	M125		89.9
446257	446256		19.69 (500)					150.7

BoxDrain Grates

Mesh Grate

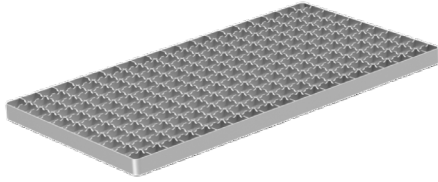

Part No. AISI 316L	Part No. AISI 304	Load Class		EN 1433	ASME	EN 1253	Slip Resistance	Open Area sq in
		To suit Box Drain Width in (mm)	Grate Length in (mm)					
416863	416862	7.87 (200)	15.75 (400)	A15	LD	L15	✓	85.1
416861	416860		19.69 (500)					106.7
416865	416864	11.81 (300)	11.81 (300)					101.8
416867	416866		19.69 (500)					172.0
416869	416868	15.75 (400)	15.75 (400)					188.5
416871	416870		23.62 (600)					284.3
416875	416874	19.69 (500)	15.75 (400)					240.4
416873	416872		19.69 (500)					302.5
416877	416876	23.62 (600)	11.81 (300)					219.4
416879	416878	31.50 (800)	15.75 (400)					360.4

Slot Cover Grate



Part No. AISI 316L	Part No. AISI 304	Load Class		EN 1433	ASME	EN 1253	Slip Resistance	Open Area sq in
		To suit Box Drain Width in (mm)	Grate Length in (mm)					
445763	445762	7.87 (200)	15.75 (400)	A15	LD	L15	✓	9.2
445757	445756		19.69 (500)					11.3
445765	445764		15.75 (400)	B125	MD	M125		9.2
445759	445758		19.69 (500)					11.3
445761	445760		15.75 (400)	C250	HD	N250		9.2
445767	445766		19.69 (500)					11.3
445775	445774	11.81 (300)	11.81 (300)	A15	LD	L15	✓	7.0
445769	445768		19.69 (500)					11.3
445777	445776		11.81 (300)	B125	MD	M125		7.0
445771	445770		19.69 (500)					11.3
445779	445778		11.81 (300)	C250	HD	N250		7.0
445773	445772		19.69 (500)					11.3

BoxDrain Outlet Connections

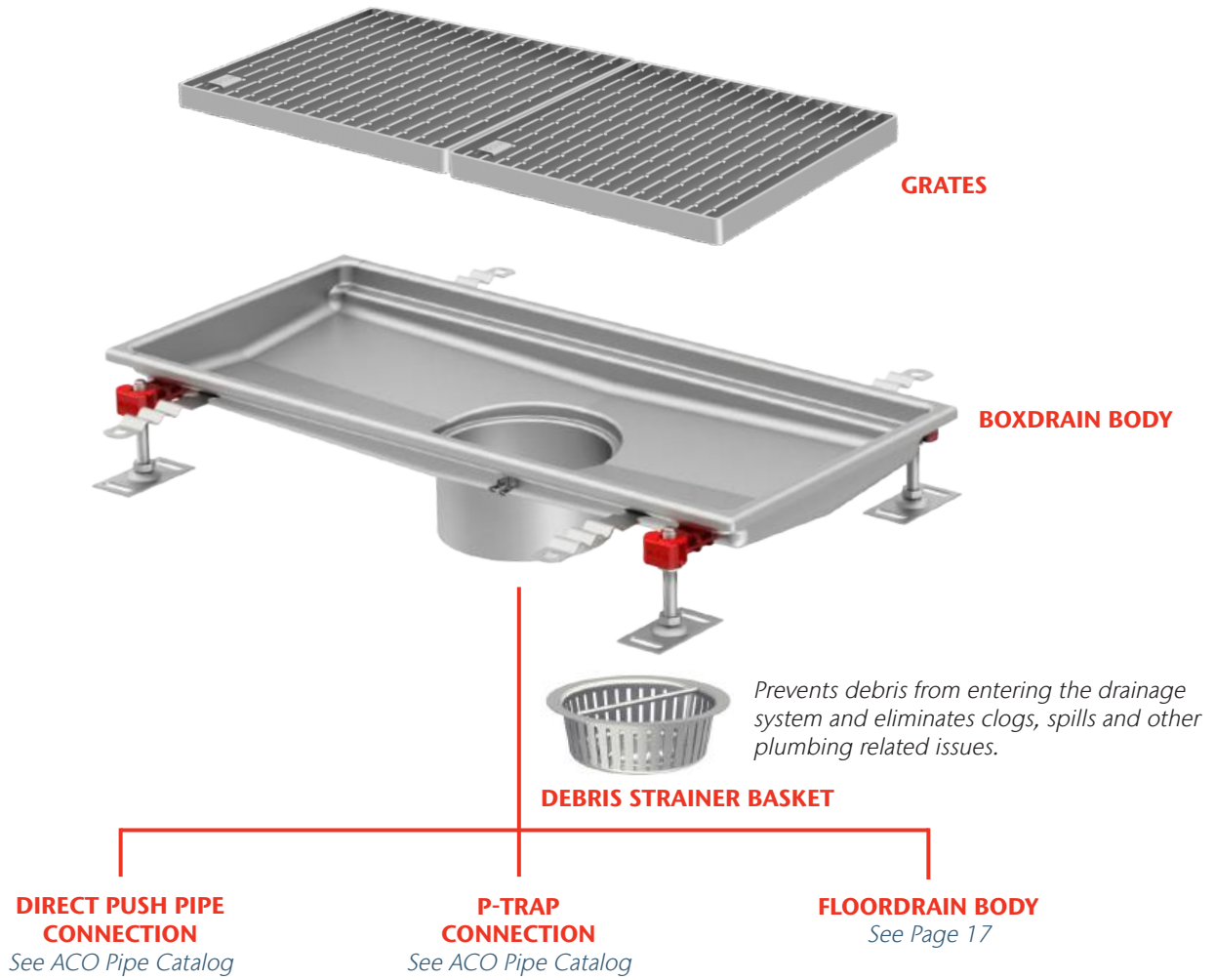

OR

LONG SWEEP P-TRAP
See ACO Pipe Catalog



BoxDrain Outlet Options

ACO stainless steel drain systems are compatible with existing underground waste water pipework.

Common Connection Types:

1. Vertical pipe spigot out of channel bottom. Simplest method to connect pipework. The connection can be made with a no-hub connector, or ACO stainless steel push-fit pipe system. ACO provides pipe and drain solutions set up prior to installation of flooring.
2. Use of a floor drain body with location flange. The floor drain body can be cast into the slab at the first concrete pour. The trench system is then set to finished height. The vertical spigot on the underside of the stainless steel trench will push-fit into the floor drain body. This gives variable height adjustment of approximately 1.1" (28 mm) vertically.
3. Use of a floor drain body with mechanical clamping flange. If the floor slab has a waterproof membrane, the membrane can be dressed into the floor drain body and the trench system installed afterwards. As with the location flange body, the vertical spigot on the underside of the stainless steel trench will push-fit into the floor drain body. This gives variable height adjustment of approximately 0.8" (20 mm) vertically.

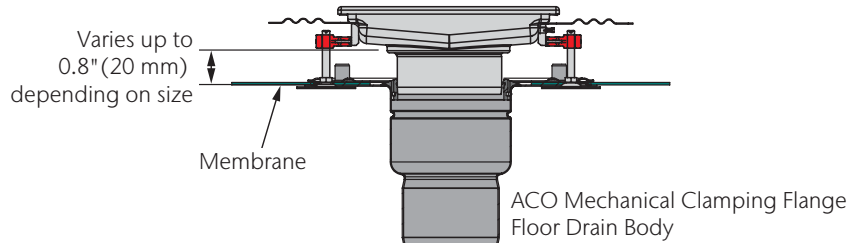
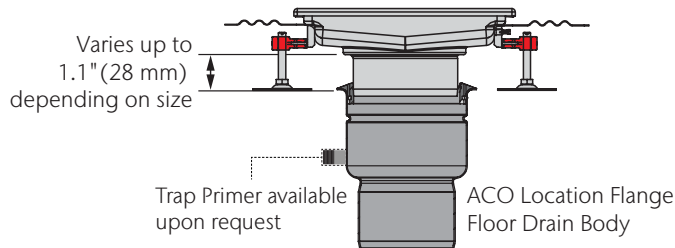
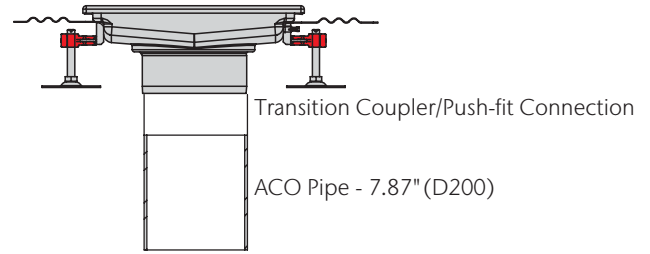

FRICION RING

When using adjustable height floor drain with **location flange**, red sealing o-ring must be used to prevent water from entering the body.

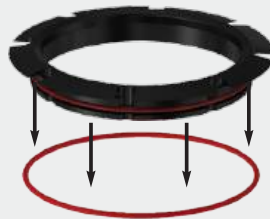

When using adjustable height floor drain with **mechanical membrane clamping flange**, red sealing o-ring must be removed to allow water to enter floor drain body through weep holes on friction ring.

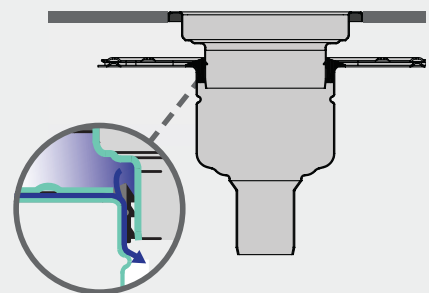
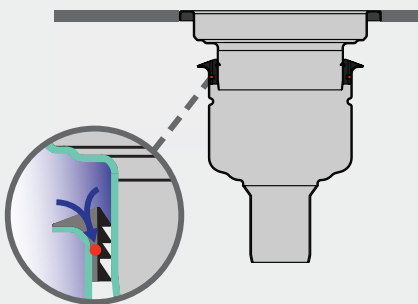

Parts Table: FloorDrain Bodies

	Part No. AISI 316L	Part No. AISI 304	Body Size	Fits Spigot Ø in (mm)	Flange Type	Outlet Ø in (mm)
Location Flange Vertical Outlet	445195	445129	10"	5.59 (142)	Location	4 (114)
	445201	445135	12"	7.87 (200)		4 (114)
	445207	445141				6 (168)



	Part No. AISI 316L	Part No. AISI 304	Body Size	Fits Spigot Ø in (mm)	Flange Type	Outlet Ø in (mm)
Location Flange Horizontal Outlet	445219	445153	10"	5.59 (142)	Location	4 (114)
	445225	445159	12"	7.87 (200)		4 (114)



	Part No. AISI 316L	Part No. AISI 304	Body Size	Fits Spigot Ø in (mm)	Flange Type	Outlet Ø in (mm)
Mechanical Membrane Clamp Vertical Outlet	445199	445133	10"	5.59 (142)	Mechanical Membrane Clamp	4 (114)
	445205	445139	12"	7.87 (200)		4 (114)
	445211	445145				6 (168)



	Part No. AISI 316L	Part No. AISI 304	Body Size	Fits Spigot Ø in (mm)	Flange Type	Outlet Ø in (mm)
Mechanical Membrane Clamp Horizontal Outlet	445223	445157	10"	5.59 (142)	Mechanical Membrane Clamp	4 (114)
	445229	445163	12"	7.87 (200)		4 (114)



*Note:
An automatic trap primer can be installed to the floor drain body to prevent the 'P' trap from drying out.
Contact ACO for details.*

Flow Rates

8" BOXDRAIN200 WITH 10" FLOOR DRAIN BODY VERTICAL OUTLET

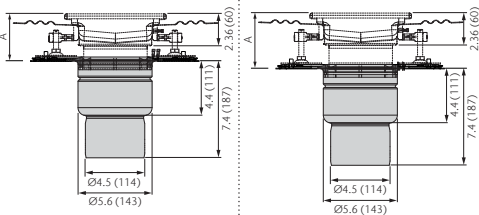

A = 2.60" (66 mm) A = 3.70" (94 mm)

Outlet Diameter (Ø) in (mm)	Flow Rate gpm	Flow Rate gpm
4" SCH10 (Ø 114 mm)	154 (9.7)	162 (10.2)

8" BOXDRAIN200 WITH 10" FLOOR DRAIN BODY HORIZONTAL OUTLET

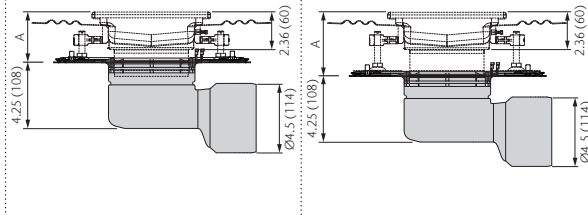

A = 2.60" (66 mm) A = 3.70" (94 mm)

Flow Rate gpm	Flow Rate gpm
111 (7.0)	121 (7.6)

12" BOXDRAIN300 WITH 12" FLOOR DRAIN BODY VERTICAL OUTLET

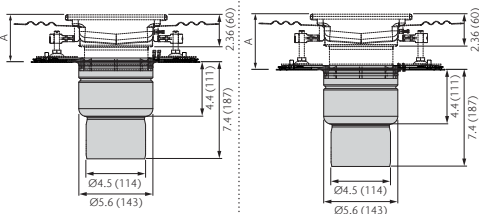

A = 2.60" (66 mm) A = 3.70" (94 mm)

Outlet Diameter (Ø) in (mm)	Flow Rate gpm	Flow Rate gpm
4" SCH10 (Ø 114 mm)	154 (9.7)	162 (10.2)
6" SCH10 (Ø 168 mm)	348 (22.0)	362 (22.8)

12" BOXDRAIN300 WITH 12" FLOOR DRAIN BODY HORIZONTAL OUTLET

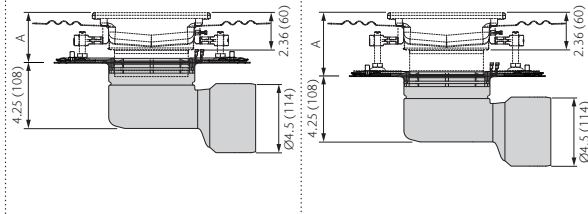

A = 2.60" (66 mm) A = 3.70" (94 mm)

Flow Rate gpm	Flow Rate gpm
111 (7.0)	121 (7.6)

16" BOXDRAIN400 WITH 12" FLOOR DRAIN BODY VERTICAL OUTLET

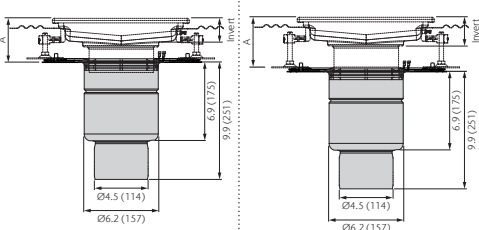

A = 2.60" (66 mm) A = 3.70" (94 mm)

Outlet Diameter (Ø) in (mm)	Flow Rate gpm	Flow Rate gpm
4" SCH10 (Ø 114 mm)	154 (9.7)	162 (10.2)
6" SCH10 (Ø 168 mm)	348 (22.0)	362 (22.8)

16" BOXDRAIN400 WITH 12" FLOOR DRAIN BODY HORIZONTAL OUTLET

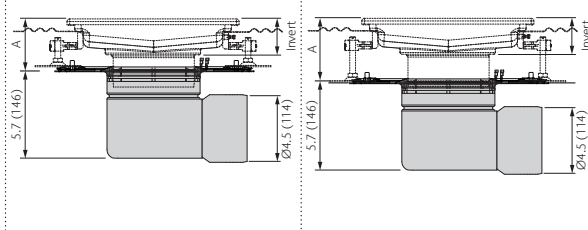

A = 2.60" (66 mm) A = 3.70" (94 mm)

Flow Rate gpm	Flow Rate gpm
111 (7.0)	121 (7.6)

Note:
 1. Silt basket and debris/solids, or foul air trap will reduce flow rates.
 2. Flow rates are based on drowned orifice calculations.
 3. Box drain inverts will impact the A min/max - min is based on shallowest invert and max is based on deepest invert.
 4. Risers are also available to increase installation heights from 1" to 3.5" or where multi waterproofing is needed. Contact ACO for details.

Flow Rates

20" BOXDRAIN500 WITH 12" FLOOR DRAIN BODY VERTICAL OUTLET

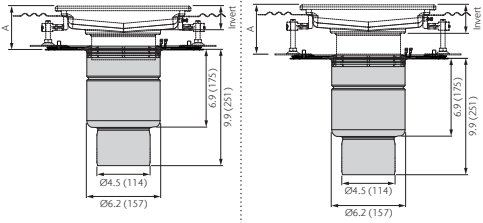

A = 2.80" (71 mm) A = 3.80" (96 mm)

Outlet Diameter (Ø) in (mm)	Flow Rate gpm	Flow Rate gpm
4" SCH10 (Ø 114 mm)	154 (9.7)	162 (10.2)
6" SCH10 (Ø 168 mm)	348 (22.0)	362 (22.8)

20" BOXDRAIN500 WITH 12" FLOOR DRAIN BODY HORIZONTAL OUTLET

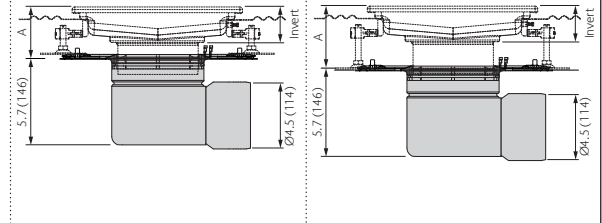

A = 2.80" (71 mm) A = 3.80" (96 mm)

Flow Rate gpm	Flow Rate gpm
111 (7.0)	121 (7.6)

24" BOXDRAIN600 WITH 12" FLOOR DRAIN BODY VERTICAL OUTLET

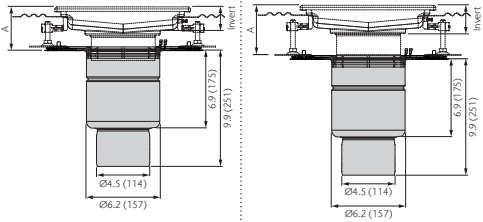

A = 3.00" (76 mm) A = 4.00" (101 mm)

Outlet Diameter (Ø) in (mm)	Flow Rate gpm	Flow Rate gpm
4" SCH10 (Ø 114 mm)	154 (9.7)	162 (10.2)
6" SCH10 (Ø 168 mm)	348 (22.0)	362 (22.8)

24" BOXDRAIN600 WITH 12" FLOOR DRAIN BODY HORIZONTAL OUTLET

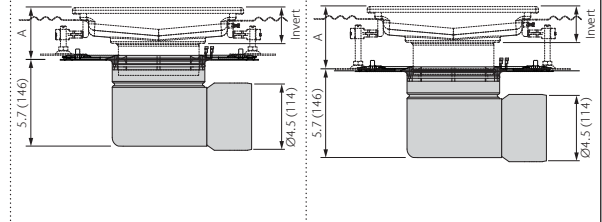

A = 3.00" (76 mm) A = 4.00" (101 mm)

Flow Rate gpm	Flow Rate gpm
111 (7.0)	121 (7.6)

32" BOXDRAIN800 WITH 12" FLOOR DRAIN BODY VERTICAL OUTLET

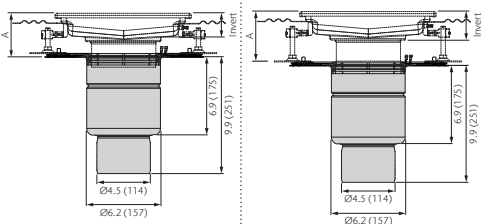

A = 3.40" (86 mm) A = 4.40" (111 mm)

Outlet Diameter (Ø) in (mm)	Flow Rate gpm	Flow Rate gpm
4" SCH10 (Ø 114 mm)	154 (9.7)	162 (10.2)
6" SCH10 (Ø 168 mm)	358 (22.6)	372 (23.5)

32" BOXDRAIN800 WITH 12" FLOOR DRAIN BODY HORIZONTAL OUTLET

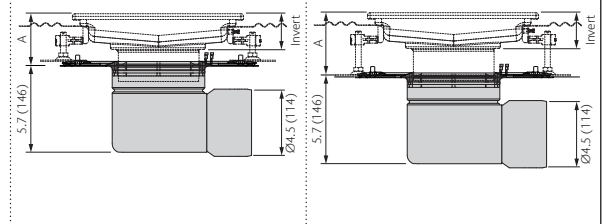

A = 3.40" (86 mm) A = 4.40" (111 mm)

Flow Rate gpm	Flow Rate gpm
111 (7.0)	121 (7.6)

Note:

1. Silt basket and debris/solids, or foul air trap will reduce flow rates.
2. Flow rates are based on drowned orifice calculations.
3. Box drain inverts will impact the A min/max - min is based on shallowest invert and max is based on deepest invert.
4. Risers are also available to increase installation heights from 1" to 3.5" or where multi waterproofing is needed. Contact ACO for details.

Semi-Custom Options

ACO's box drains can be customized to fit specific configurations. Typical non-standard stainless steel drainage can include custom widths, special grates, and unique depth configurations. ACO has years of experience with these types of applications, and in instances where a standard or modified standard product cannot fulfil the project, please contact us.

Customers' individual project designs can be managed by our expert team with tailored services for specific projects, including complete technical support, CAD layout drawings and assembly instructions.

Contact our Sales/Technical department team to help find the best solution.

Customizations:

- Custom widths
- Custom depths
- Custom edge profile
- Built-in back splash upstand
- Custom invert depths
- Different gauge of material for box drain body
- Outlet position along box drain
- Custom silt baskets



CHANNEL EDGE OPTIONS

All ACO BoxDrain's are available with different edge details to suit varying load requirements and the surrounding floor material.

STANDARD EDGE

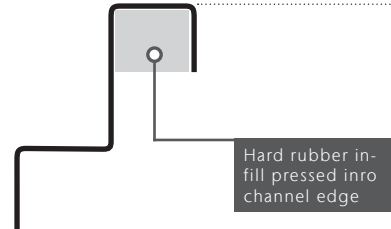

Suitable for tiled, concrete and epoxy resin floors in pedestrian and light industrial applications. Drains without infill are susceptible to failure as the surrounding concrete rarely fills that void. As edges compress, cavities create breeding grounds for pathogens and are impossible to clean. Edge in-fill in other materials - contact ACO for details.

SEMI-CUSTOMIZATION - ALTERNATIVE EDGE OPTIONS

SOLID STEEL EDGE IN-FILL - heavy duty

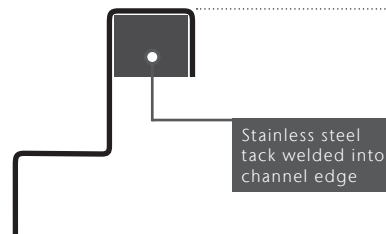

ACO recommends the use of a solid steel edge in-fill when using class E grates or where fork lift traffic is expected.

EPOXY EDGE IN-FILL - tile floors

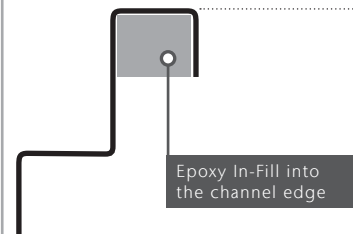

Suitable for medium traffic load, providing a high quality connection between the drainage and floor tiles. Pur In-Fill is ideal for use in multiple applications including the beverage industry, pharmaceutical and chemical industries.

EXTENDED EDGE - tile floors

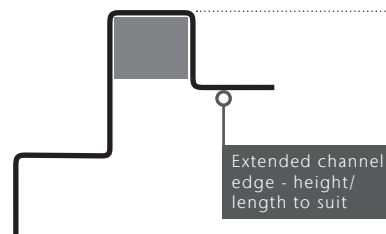

Suitable for tiled floors in pedestrian and light industrial applications.

FLOOR ANGLE EDGE - heavy duty resin floor

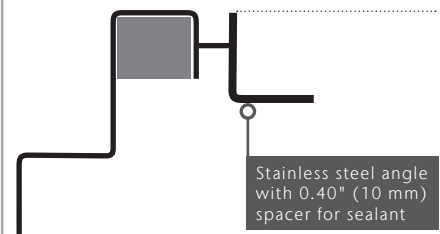

Suitable for heavy duty tiled, paver and resin floor applications, isolates channel from floor and provides gap for sealant. If deeper steel angle required contact ACO.

Stainless Steel BoxDrain Installation Guide

Box drain connected to ACO Floor Drain Body with location flange (concrete floor)

- 1 Epoxy/resin floor
- 2 Screed
- 3 Solid concrete floor slab
- 4 Compacted soil
- A Location flange floor drain body
- B Grate
- C Friction ring with red O-ring
- D Outlet pipe connection

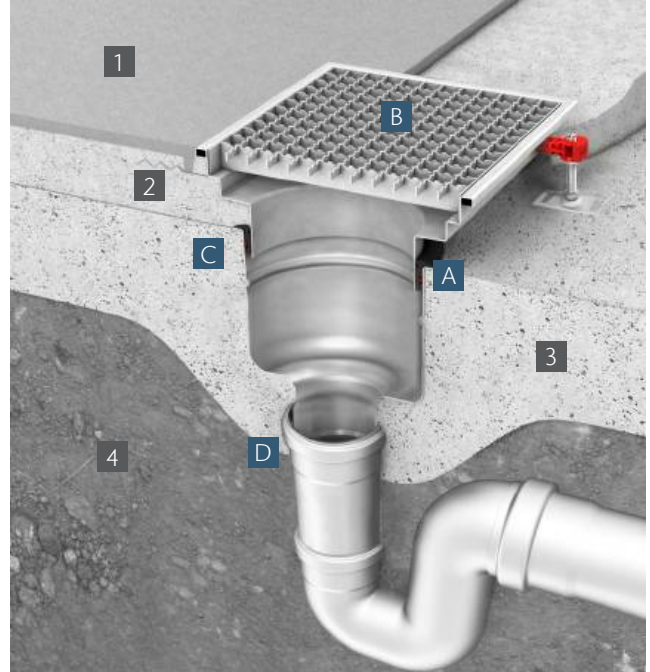

Box drain connected to ACO Floor Drain Body with membrane clamping flange (tiled floor)

- 1 Tile
- 2 Cement/tile adhesive
- 3 Flexible sealant
- 4 Waterproof membrane
- 5 Screed
- 6 Solid concrete floor slab
- 7 Compacted soil
- A Mechanical flange floor drain body
- B Grate
- C Friction ring without red O-ring
- D Outlet pipe connection

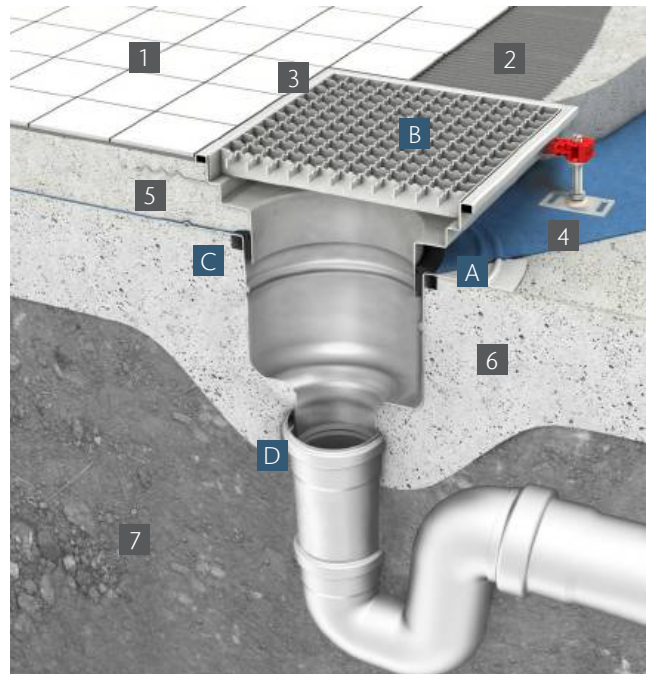

Post-Install Cleaning:

- 21 Remove all protective tape from the channel edge and clean the surface with a solvent if necessary to remove any adhesive residue. Wash and clean the channel (and floor drain if applicable), empty silt basket and refit grates.

Glossary

Anti-slip grate - grates certified to offer improved grip.

Axle load - load carried by each axle of vehicle.

Channel - one section of a modular trench drain system.

Clamping flange - metal plate with mechanical fixing (bolts) that allows a floor membrane to be dressed into floor drain.

Debris strainer basket - perforated basket to collect larger volumes of sediment/debris passing into pipework.

Electropolished - electrolytic process producing a highly reflective luster which offers chemical and bacterial resistance.

Flow rate - quantity of liquid evacuated through outlet in a given time frame - gallons per minute (GPM).

Foul air trap - drain section designed to prevent odors traveling up from underground waste water system.

Heelsafe - per ASME A112.6 - maximum grate hole size in least dimension of 0.31", deemed safe for high-heeled shoes.

Invert depth - depth from top of grate to inside base of channel.

Leveling feet - fixed to base of channels to allow height and level adjustment.

Linished - brushed effect usually on channel edge surface.

Load class - ability of grate to resist load specified in a load standard.

Pickled & passivated - chemical descaling and coating of stainless steel part to restore corrosion and chemical resistance qualities.

Point load - load exerted through an area for specification and testing purposes.

Rubber infill - strip inserted to underside of channel edge, prevents concrete voids during installation and improves loading performance. Stainless steel infill available for heavy duty applications.

Sieve - perforated plate to prevent sediment/debris passing into pipework.

Spigot - section of pipe used for outlet connection, may require a coupler.

Trench drain - an assembly of channels that make up a linear drain.

Wheel load - load exerted through one wheel of vehicle/trolley.



askACO

Every project brings its own requirements and challenges. In addition to our products, ACO offers you our knowledge and services to jointly develop tailor-made solutions from planning to after-sales support. With our extensive network of sales and support representation, ACO strives to ensure that the needs of your project are professionally and efficiently met.



train

Information and further education

At ACO, we share the expertise of the global ACO Group with architects, engineers, installers, and distributors who value quality. We invite you to benefit from it.



design

Planning and optimization

There are many drainage solutions to consider when planning a project. But which option leads to the most economically and technically safest solution? We help you to find the right answer.





support

Construction advice and presence

To prevent unpleasant surprises between planning and implementation stages, we advise and support you on a project-specific basis.



care

Inspection and maintenance

ACO products are designed and produced to last. With our after-sales support, we ensure that ACO will exceed your standards for years to come.

ACO ON THE WEB

You will find further information for our products on the ACO Building Drainage website. This allows you to access technical data, images, specifications, and installation instructions during planning.

www.acocan.ca
www.acobd.com

www.askACO.ca

ACO products support the ACO System Chain



Building Drainage

- ACO Stainless - Stainless Trench Drains
- ACO BoxDrain - Stainless Hygienic Drains
- ACO FloorDrain - Stainless Point Drains
- ACO Pipe - Stainless Push-fit Piping
- ACO ShowerDrain - Bathroom Drainage

Surface Water Management

- ACO Drain - Commercial Trench Drains
- ACO Infrastructure - Heavy Duty Drainage
- ACO Sport - Athletic Venue Drainage
- ACO StormBrixx - Geocellular Tanks
- ACO Aquaduct - Custom Drainage
- ACO Environment - Solid & Oil Separators
- ACO Wildlife - Guidance & Passage
- ACO Self - Garden & Landscape Drainage
- ACO UtilityDuct - Ducting System

ACO Systems, Ltd.

East Sales Office
2910 Brighton Road
Oakville, ON L6H 5S3
Tel: (905) 829-0665
Toll Free: (888) 490-9552
Fax: (905) 829-2908

West Sales Office
#311 - 3602 Gilmore Way
Burnaby, BC V5G 4W9
Tel: (604) 554-0688
Fax: (604) 554-0693

info@acocan.ca
www.acocan.ca
www.acobd.com

© July 2022 ACO, Inc.

All reasonable care has been taken in compiling the information in this document. All recommendations and suggestions on the use of ACO products are made without guarantee since the conditions of use are beyond the control of the company. It is the customer's responsibility to ensure that each product is fit for its intended purpose and that the actual conditions of use are suitable. ACO, Inc. reserves the right to change products and specifications without notice.

Print #BD201

ACO. we care for water

